

# MOBILE AND STATIONARY EXTRACTION SYSTEMS



YOUR  
ASSET  
AT WORK.





## MORE EFFICIENCY, MORE CONVENIENCE, MORE JOY AT WORK

Work is easier in clean air.

Thanks to the unique AL-KO OPTI JET® technology AL-KO extraction systems remove dust and swarf from your work stations and valuable machinery. Without extensive downtime, but with predictable maintenance intervals, low-noise and energy-efficient.

.....	Page
About us .....	04 – 05
The AL-KO principle .....	06 – 07
Mobile pure air dust extractors POWER UNIT .....	08 – 15
Stationary compact filter systems ECO JET .....	16 – 17
Stationary system filter equipment PROFI JET .....	18 – 19
Raw air dust collectors MOBIL and AAS .....	20 – 21
Paint mist extractors COLOUR JET .....	22
Ventilation extraction fan AL-KO BAG .....	23
Safety vacuum cleaners JET STREAM .....	23
Briquette presses .....	24
Rotary lock valves and discharges .....	25
Planning and installation.....	26
Life cycle costs.....	27



AL-KO extraction systems are developed in the Bavarian Jettingen-Scheppach, tested under various operating conditions and manufactured at the Jettingen-Scheppach and Lutherstadt Wittenberg plants with loving attention to quality. This guarantees you are investing in a quality product which you will enjoy on a daily basis for years to come.



## LIFE IN PURSUIT OF QUALITY – FROM THE VILLAGE FORGE TO A GLOBAL CORPORATION

AL-KO KOBER SE was founded in 1931 by Alois Kober as a small metalworking shop in the Bavarian-Swabian town of Großkötz, near Günzburg.

The third generation to run this family business, it is still managed as per the founder's wishes: constantly striving for quality, innovation and carefully designed functionality.

The Directors of AL-KO KOBER SE  
(from right to left):  
Stefan Kober (CEO) and Dr. Nico Reiner (CFO)

# AL-KO EXTRACTION TECHNOLOGY ENGINEERED AND MADE IN GERMANY

# THE AL-KO PRINCIPLE

## QUALITY FOR LIFE



We take the promise "Quality for Life" very seriously. How seriously becomes evident when looking at the age AL-KO extraction systems reach on average. This is why, along with an AL-KO extraction system, you are purchasing the certainty of investing in your company's future, the stability of your operations and your team's motivation.

### EFFICIENCY AND OCCUPATIONAL SAFETY

Thanks to their long filter service life, performance and cost effectiveness, AL-KO extraction systems significantly contribute to increasing efficiency and occupational safety.

### THERE IS SAFETY IN SIZE

When it comes to extraction systems AL-KO can build on almost 30 years of experience in extraction technology. Most of all, however, AL-KO can rely on an experienced team of engineers, design engineers and production employees who live by our guiding principle "Quality for Life". What applies to technology also applies to the commercial side: AL-KO is a financially strong company with offices worldwide. This gives you long-term investment security.

### FOR YOU, NEAR YOU

AL-KO extraction systems can be obtained worldwide from AL-KO professional partners. Mobile systems are also sold by your AL-KO specialist dealer. This provides you with an approved, local point of contact who is always available with help and advice at the right time, backed by AL-KO as a strong manufacturer.

### TWICE AS GOOD

The often copied, but never paralleled AL-KO OPTI JET® principle is different from other solutions in that it solely works with air jets. To put it simply: The polluted air is sucked in, swarf and dust settle on the filter and form a so-called filter cake which is blasted off at regular intervals by jets of compressed air. A pleasant side effect: This blow lasts approximately 0.1 seconds and is generated from the existing airflow. Only 1/7 of the compressed air is generated by the compressor which positively affects energy consumption. This demonstrates once again the AL-KO OPTI JET® principle's superiority over other systems and conventional vibration technology.

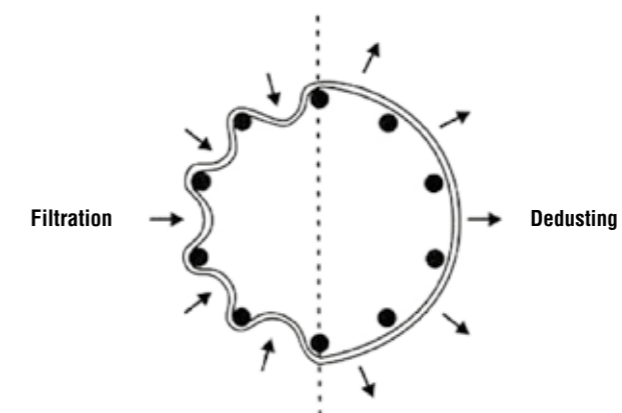
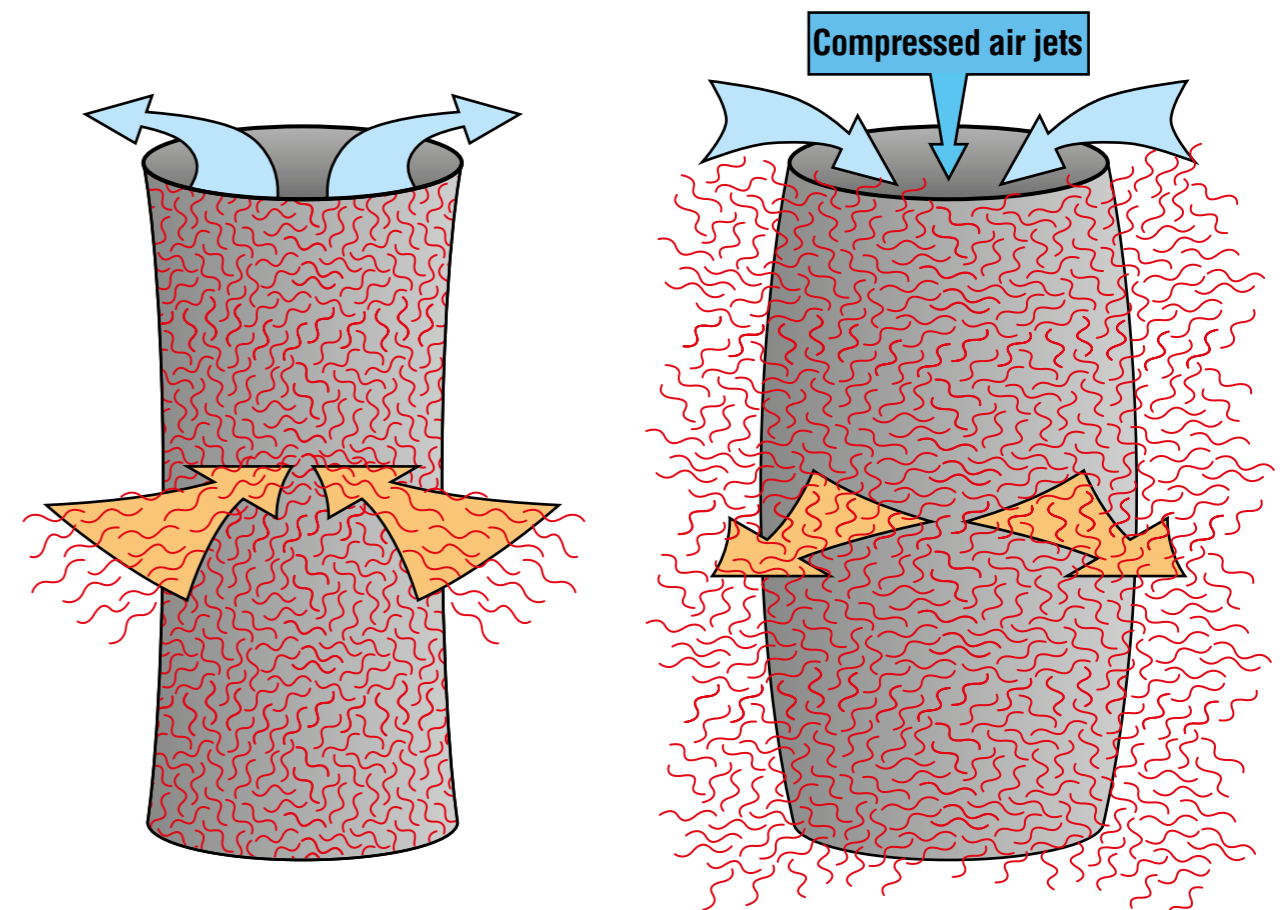
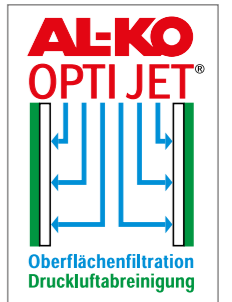

# MOBILE PURE AIR DUST EXTRACTOR POWER UNIT

## CLEAN AIR FOR ALL LEVELS OF PERFORMANCE



- | Efficient and economical: Large air surge tank with fast diaphragm valves for effective OPTI JET® filter cleaning and lowest use of compressed air.
- | So simple and yet so effective: OPTI JET® dedusting and filter bag with snap ring lock.
- | Highly economical: energy-efficient motors according to IE2.
- | Safety in case of emergencies: Low-maintenance automatic fire extinguishing system (standard from POWER UNIT 250).
- | Completely calm: sound-insulated air recirculation by AL-KO.
- | All options are available: PLC control system for manual and automated operation (from POWER UNIT 140). Countless options from machine recognition to slide valve control and frequency-controlled operation to name but three.
- | No mess: container with window for visual checks.
- | Practical down to the last detail: container lock with ergonomic tension lever.
- | Retroactively extendable: Conversion to discharge via briquette press or rotary lock valve possible (from POWER UNIT 140).

### The advantages for you:

- | High extraction performance
- | Compact design
- | 100% air recirculation without loss of temperature (residual dust < 0.1 mg/m³)
- | Integrated pre-separator and extendable control system
- | Optimum filter dedusting
- | Minimal noise level

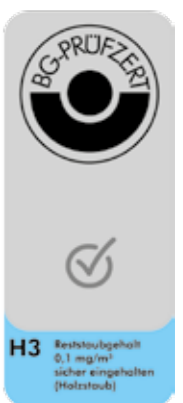

# MOBILE PURE AIR DUST EXTRACTORS

## THE PERFECT SOLUTION FOR ANY EQUIPMENT



### AL-KO POWER UNIT 100 / 120

Technical data	100	100	120	120 M**
Extraction nozzles	100 mm	100 mm	120 mm	120 mm
Nominal motor rating	1.1 kW / 1 Ph	1.5 kW / 3 Ph	1.5 kW / 3 Ph	1.5 kW / 3 Ph
Voltage	230 V / 50 Hz	400 V / 50 Hz	400 V / 50 Hz	400 V / 50 Hz
Max. flow rate	790 m³ / h	790 m³ / h	1,140 m³ / h	1,140 m³ / h
Nominal flow rate*	565 m³ / h	565 m³ / h	814 m³ / h	814 m³ / h
Vacuum at nominal flow rate	2,118 Pa	2,124 Pa	2,180 Pa	2,180 Pa
Filter area	4.1 m²	4.1 m²	5.1 m²	5.1 m²
Swarf collection capacity	approx. 135 L	approx. 135 L	approx. 135 L	approx. 135 L
Sound pressure level***	69 dB(A)	69 dB(A)	71 dB(A)	71 dB(A)
Dimensions (L / W / H) in mm	1,178 x 650 x 1,973	1,178 x 650 x 1,973	1,178 x 650 x 1,973	1,178 x 650 x 1,973
Weight netto	approx. 114 kg	approx. 116 kg	approx. 117 kg	approx. 121 kg

\*GS-HO-07 \*\* M – Version with automatic filter dedusting and machine detection \*\*\* Free sound field measurement according to DIN EN 11201



### AL-KO POWER UNIT 200

Technical data	200 P	200 P-BP	200 P-ZRS
Extraction nozzles	200 mm	200 mm	200 mm
Nominal motor rating	3.0 kW / 3 Ph	3.0 kW / 3 Ph	3.0 kW / 3 Ph
Voltage	400V / 50Hz	400V / 50Hz	400V / 50Hz
Max. flow rate	3,010 m³ / h	3,010 m³ / h	3,010 m³ / h
Nominal flow rate*	2,262 m³ / h	2,262 m³ / h	2,262 m³ / h
Vacuum at nominal flow rate	2,174 Pa	2,174 Pa	2,174 Pa
Filter area	13.8 m²	13.8 m²	13.8 m²
Filter dedusting	Pressurised air	Pressurised air	Pressurised air
Swarf collection capacity (net / gross)	2 x 165 L / 2 x 241 L	Briquette press	Rotary lock valve
Sound pressure level***	72 dB(A)	72 dB(A)	72 dB(A)
Dimensions (L / W / H) in mm	2,296 x 830 x 2,050	2,296 x 1,314 x 2,467	2,296 x 836 x 2,266
Briquette / rotary lock valve performance	–	30 – 40 kg / h**	15,744 L / h**
Briquette diameter	–	40 mm	–
Weight netto	460 kg	950 kg	550 kg

\*GS-HO-07 \*\* depending on the material \*\*\* free sound field measurement according to DIN EN 11201



### AL-KO POWER UNIT 140 / 160

Technical data	140 P / 140 H	160 K**	160 P / 160 H
Extraction nozzles	140 mm	160 mm	160 mm
Nominal motor rating	2.2 kW / 3 Ph	2.2 kW / 3 Ph	2.2 kW / 3 Ph
Voltage	400 V / 50 Hz	400 V / 50 Hz	400 V / 50 Hz
Max. flow rate	1,600 m³ / h	2,000 m³ / h	2,000 m³ / h
Nominal flow rate*	1,108 m³ / h	1,448 m³ / h	1,448 m³ / h
Vacuum at nominal flow rate	2,591 Pa	2,503 Pa	2,503 Pa
Filter area	6.3 m²	9.1 m²	9.1 m²
Filter dedusting	Pressurised air / manual	Pressurised air	Pressurised air / manual
Swarf collection capacity (net / gross)	165 L / 241 L	165 L / 241 L	165 L / 241 L
Sound pressure level***	69 dB(A)	69 dB(A)	69 dB(A)
Dimensions (L / W / H) in mm	1,688 x 830 x 2,050	1,688 x 830 x 2,050	1,688 x 830 x 2,050
Weight netto	330 / 320 kg	350 kg	340 / 330 kg

\*GS-HO-07 \*\* K – integrated compressor \*\*\* free sound field measurement according to DIN EN 11201

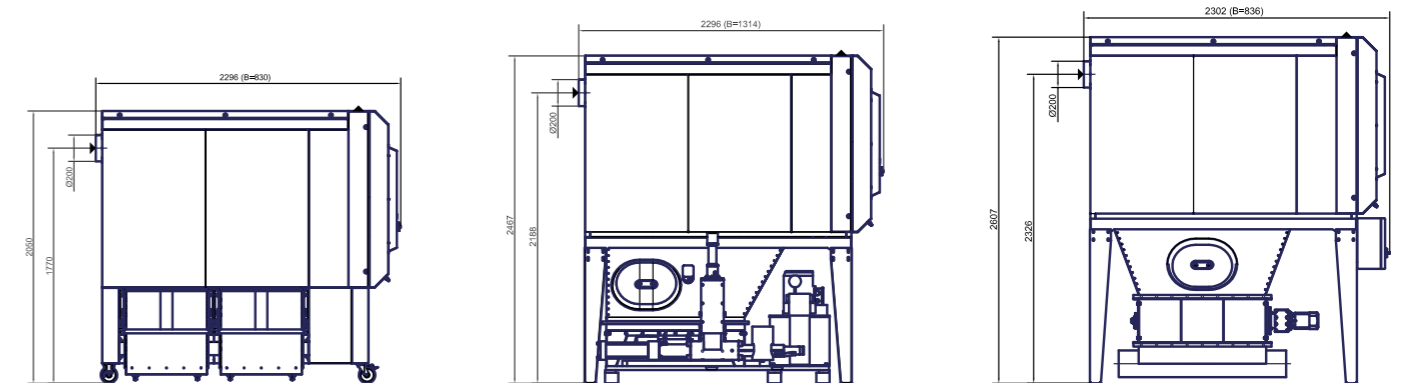



## AL-KO POWER UNIT 250

Technical data	250 P	250 P-BP	250 P-ZRS
Extraction nozzles	250 mm	250 mm	250 mm
Nominal motor rating	6.5 kW / 3 Ph	6.5 kW / 3 Ph	6.5 kW / 3 Ph
Voltage	400 V / 50 Hz	400 V / 50 Hz	400 V / 50 Hz
Max. flow rate	4,900 m <sup>3</sup> / h	4,900 m <sup>3</sup> / h	4,900 m <sup>3</sup> / h
Nominal flow rate*	3,534 m <sup>3</sup> / h	3,534 m <sup>3</sup> / h	3,534 m <sup>3</sup> / h
Vacuum at nominal flow rate	2,451 Pa	2,451 Pa	2,451 Pa
Filter area	22.4 m <sup>2</sup>	22.4 m <sup>2</sup>	22.4 m <sup>2</sup>
Swarf collection capacity (net / gross)	2 x 165 L / 2 x 250 L	Briquette press	Rotary lock valve
Sound pressure level***	72 dB(A)	72 dB(A)	72 dB(A)
Dimensions (L / W / H) in mm	2,340 x 1,058 x 2,351	2,340 x 1,329 x 2,609	2,352 x 1,058 x 2,797
Briquette / star feeder performance	–	30 – 50 kg / h**	15,744 L / h**
Briquette diameter	–	50 mm	–
Weight netto	758 kg	1,381 kg	728 kg

\*GS-HO-07 \*\* depending on the material \*\*\* free sound field measurement according to DIN EN 11201



## AL-KO POWER UNIT 300

Technical data	300 P	300 P-BP	300 P-ZRS
Extraction nozzles	300 mm	300 mm	300 mm
Nominal motor rating	7.49 kW / 3 Ph	7.49 kW / 3 Ph	7.49 kW / 3 Ph
Voltage	400 V / 50 Hz	400 V / 50 Hz	400 V / 50 Hz
Max. flow rate	6,000 m <sup>3</sup> / h	6,000 m <sup>3</sup> / h	6,000 m <sup>3</sup> / h
Nominal flow rate*	5,089 m <sup>3</sup> / h	5,089 m <sup>3</sup> / h	5,089 m <sup>3</sup> / h
Vacuum at nominal flow rate	2,434 Pa	2,434 Pa	2,434 Pa
Filter area	30 m <sup>2</sup>	30 m <sup>2</sup>	30 m <sup>2</sup>
Swarf collection capacity (net / gross)	3 x 165 L / 3 x 250 L	Briquette press	Rotary lock valve
Sound pressure level***	71 dB(A)	71 dB(A)	71 dB(A)
Dimensions (L / W / H) in mm	2,985 x 1,058 x 2,351	2,985 x 1,352 x 2,803	2,997 x 1,058 x 3,013
Briquette / star feeder performance	–	50 – 70 kg / h**	15,744 L / h**
Briquette diameter	–	70 mm	–
Weight netto	952 kg	1,570 kg	920 kg

\*GS-HO-07 \*\* depending on the material \*\*\* free sound field measurement according to DIN EN 11201

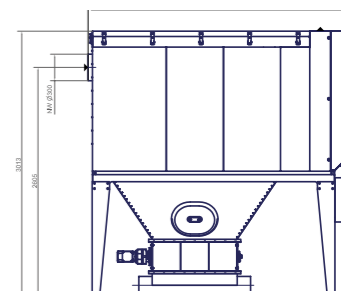
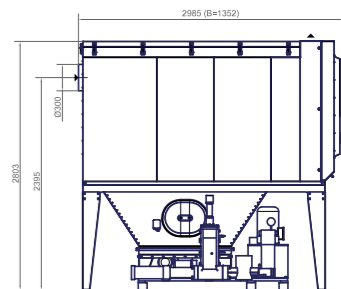
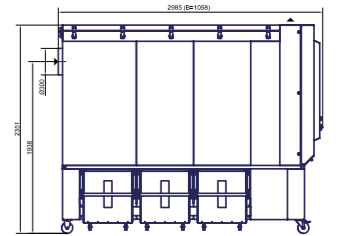
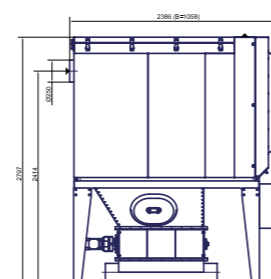
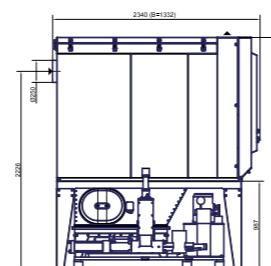
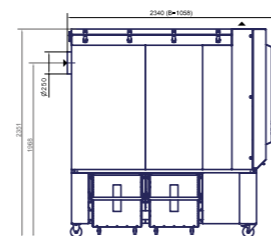

# MOBILE PURE AIR DUST EXTRACTORS

## THE NEW PERFORMANCE CLASS

### THE NEW LEVEL OF PERFECTION

- | New technology
- | Unique design
- | Made in Germany
- | Patent pending



AL-KO POWER UNIT 350 is the new performance class among pure air dust extractors. The powerful 11 kW **IE3 motor** extracts dust and swarf with a gigantic **flow rate of more than 8,000 m³/h**, while being very economical in terms of consumption. Thanks to 57 washable filters, the AL-KO POWER UNIT 350 offers a **gigantic filter surface** of 73 m² – enough to lower the residual dust content of the **air which is 100% recycled** to < 0.1 mg/m³ (H3).

Naturally, the AL-KO POWER UNIT 350 uses tried and tested, and further improved, AL-KO OPTI JET® technology and the **integrated pre-separator** comes as standard. While performing on a gigantic level, AL-KO POWER UNIT 350 is never noisy. The maximum sound level at a distance of one meter measures according to DIN EN ISO 11201 – **absolutely quiet 71 dB (A)** – probably the lowest figure in this class. This is not surprising as the AL-KO POWER UNIT 350 **is equipped with real sound-absorbing panels – as standard.**

Thanks to the unique design and the further optimised internal layout, AL-KO POWER UNIT 350 is extremely space-saving: with its dimensions of 3.112 x 1.058 x 2.361 mm (LxWxH) the AL-KO POWER UNIT 350 is significantly smaller than many other devices of the 300 class.

## AL-KO POWER UNIT 350

Technical data	350 P	350 P-BP	350 P-ZRS
Extraction nozzles	350 mm	350 mm	350 mm
Nominal motor rating	11,0 kW/3 Ph	11,0 kW/3 Ph	11,0 kW/3 Ph
Voltage	400 V/50 Hz	400 V/50 Hz	400 V/50 Hz
Max. flow rate	approx. 8.500 m³/h	approx. 8.500 m³/h	approx. 8.500 m³/h
Nominal flow rate*	6.927 m³/h	6.927 m³/h	6.927 m³/h
Vacuum at nominal flow rate	2.543 Pa	2.543 Pa	2.543 Pa
Filter area	73 m²	73 m²	73 m²
Swarf collection capacity (net / gross)	3 x 165 L / 3 x 250 L	Briquette press	Rotary lock valve
Sound pressure level***	71 dB(A)	71 dB(A)	71 dB(A)
Dimensions (L / W / H) in mm	3.112 x 1.058 x 2.361	3.112 x 1.323 x 2.817	3.159 x 1.058 x 3.027
Briquette / star feeder performance	–	50 – 70 kg/h**	15.744 L/h**
Briquette diameter	–	70 mm	–
Weight netto	1.020 kg	1.605 kg	920 kg

\* Exposed to dust according to GS-H0-07    \*\*depending on the material    \*\*\* free sound field measurement according to DIN EN 11201

# AL-KO DUST COMPARTMENT

## PRACTICAL - SIMPLE - CLEAN

The AL-KO DUST COMPARTMENT, the simple, patented and inexpensive solution for greater cleanliness and health protection in the workplace.

### The advantages for you:

- | Easy to operate
- | Dust-free wind-up during container changes
- | Bag removal with lifting machine
- | Optimised health protection



Release the chippings container



Push in the dust compartment



Replace the chippings container



Reinsert the chippings container and remove the dust compartment



Clamp the chippings container into place



# STATIONARY COMPACT FILTER SYSTEM ECO JET

## THE CLEANEST FORM OF SECURITY OF INVESTMENT



While developing the ECO JET compact filter systems, AL-KO focussed on three goals: maximum security of investment, exceedingly low operating costs and highest convenience. This is why every ECO JET system is of course fitted with the unique AL-KO OPTI JET® filter system. For you and your valuable machinery this means cleaner air, constant extraction performance, lower energy consumption, less noise and vibration, longer filter service life and thus less downtime as well as predictable maintenance intervals.

In addition, the programmable controller enables you to make changes at any time with little effort. That's security of investment you can enjoy on a daily basis.

### The advantages for you:

- | Permanently clean air for people and machines
- | Low energy consumption
- | Less downtime and predictable maintenance intervals
- | Low sound and vibration emission
- | Easy to extend



Technical data	3 A-L-XL	4 A-L-XL	5 A-L-XL	6 A-L-XL
Vacuum at nominal flow rate	3,700 – 4,200 Pa	2,500 – 4,200 Pa	2,100 – 3,700 Pa	2,250 – 3,000 Pa
Motor rating	5.5 – 11 kW	7.5 – 15 kW	7.5 – 15 kW	11 – 18.5 kW
Flow rate	2,500 – 4,200 m³ / h	6,045 – 10,000 m³ / h	6,045 – 10,000 m³ / h	7,770 – 10,000 m³ / h
Filter area	23 – 38.8 m²	28.8 – 58.2 m²	40.3 – 77.6 m²	51.8 – 97 m²
Depth	1,122 – 1,315 mm	1,122 – 1,315 mm	1,122 – 1,315 mm	1,122 – 1,315 mm
Length	2,440 mm	3,188 mm	3,950 mm	4,563 mm
Height	2,959 – 4,832 mm	2,959 – 5,291 mm	2,959 – 5,150 mm	2,959 – 4,059 mm

Technical data	DUO 6 A-L-XL	DUO 8 A-L-XL	DUO 10 A-L-XL
Vacuum at nominal flow rate	2,100 – 4,700 Pa	2,100 – 4,700 Pa	2,100 – 4,700 Pa
Motor rating	15 – 18.5 kW	2 x 11 – 2 x 15 kW	2 x 11 – 2 x 18.5 kW
Flow rate	5,700 – 13,000 m³ / h	8,000 – 17,000 m³ / h	8,000 – 25,000 m³ / h
Filter area	57.6 – 97 m²	69.2 – 116.4 m²	92 – 155.2 m²
Depth	2,121 – 2,173 mm	2,121 – 2,296 mm	2,121 – 2,296 mm
Length	2,530 mm	3,188 mm	3,919 mm
Height	3,610 – 5,277 mm	3,610 – 5,597 mm	3,996 – 5,597 mm

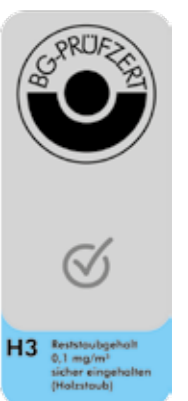

# STATIONARY SYSTEM FILTER EQUIPMENT PROFI JET

## JUST THE WAY YOU NEED IT TO BE

AL-KO PROFI JET system filter equipment combines individuality and standardisation in an ingenious way: together with your AL-KO professional partner you create the solution most suited for your requirements from a wide range of standard components. The modular design ensures a cost-effective and fast setup of your system as well as its flexibility to grow with your organisation and adapt to changing requirements in the course of the years.

Whichever way you choose to build it, all PROFI JET systems are of course fitted with the highly efficient AL-KO OPTI JET® system for ideal air filtration, low downtime and minimal energy consumption. The panel construction with integrated heat insulation also contributes to this. It is designed for the cleaned return air to hardly cool down. At the same time, the 48 mm strong outer wall offers optimum noise protection. Certified to EW 90 standard, it is fire-retardant and provides explosion protection up to 200 mbar shock resistance.

- | Efficient and economical: Large air surge tank with fast diaphragm valves for effective OPTI JET® filter cleaning and lowest use of compressed air.
- | Safely regulated: process fans according to ErP Directive 2009/125/EC.
- | Safeguarding good neighbourhood relations: sound-insulated return air chamber, optionally with sound-absorbing panels providing the lowest sound emission values on the market.
- | Optimum efficiency: OPTI JET® filter bag (BGIA-tested for dust class M).
- | According to your preference: Discharge made from galvanised steel plates or welded and powder-coated.
- | AL-KO rotary lock valve pressure-tested according to ATEX Directive 94/9/EG.
- | They soon pay themselves off: AL-KO briquette presses.



### The advantages for you:

- | Individual solution with cost-effective standard components
- | AL-KO OPTI JET® technology for cleaner air, less downtime and lower energy consumption
- | Security of investment as the system can grow and change along with the business
- | Integrated insulation for minimal temperature loss
- | Integrated fire and explosion protection

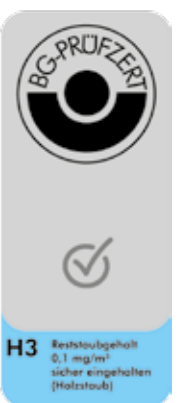

# RAW AIR DUST COLLECTORS MOBIL AND AAS

## THE ROBUST SOLUTION FOR CLEANER AIR

Whether you need to extract dust, swarf or plastic, polystyrene, paper, metal or glass waste, at different locations or stationary, AL-KO raw air dust collectors MOBIL and AAS are characterised by optimum extraction performance, robust construction and convenient handling. Both ranges of models ensure a significant reduction of dust levels (class L). Short installation periods and quick-release brackets for fastening the standardised swarf bags simplify work. The AAS series also offers the possibility of switching to swarf collection bins, either as part of the original equipment or at a later stage. Filter cartridges can be refitted at any stage as well.

### The advantages for you:

- | Exceptional value for money
- | Robust design
- | Easy to operate
- | Outstanding extraction performance
- | Wide range of possibilities for retrofitting



## MOBIL 100 – 200

Technical data	100*	125W / 125D	140W / 140D	160	200
Extraction nozzles	100 mm	125 mm	140 mm	160 mm	200 mm
Nominal motor rating	0.75 kW / 1 Ph	0.75 kW / 1 Ph / 0.75 kW / 3 Ph	1.1 kW / 1 Ph / 0.75 kW / 3 Ph	1.5 kW / 3 Ph	2.2 kW / 3 Ph
Voltage	230 V / 50 Hz	230 V/50 Hz/400 V/50 Hz	230 V/50 Hz/400 V/50 Hz	400 V / 50 Hz	400 V / 50 Hz
Flow rate	865 m³ / h	1,350 m³ / h	1,650 m³ / h	2,200 m³ / h	2,500 m³ / h
Vacuum at nominal flow rate	1,780 Pa	1,600 Pa	1,750 Pa	2,500 Pa	2,700 Pa
Filter area	1.1 m²	1.9 m²	1.9 m²	1.9 m²	2.2 m²
Swarf collection capacity	90 L	175 L	175 L	175 L	175 L
Dimensions (L / W / H) in mm	883 x 479 x 1622	1,061 x 577 x 2,100	1,061 x 577 x 2,100	1,061 x 577 x 2,100	1,061 x 577 x 2,300
Weight netto	26 kg	51 kg / 53 kg	52 kg / 53 kg	53 kg	60 kg

\*2 m hose included in the delivery

!! Use in the wood industry is not permitted in Germany, Austria and Switzerland !!



## AAS 1013 – 6013

Technical data	1013	2013	3013	4013	5013	6013
Extraction nozzles	160 mm	160 mm	200 mm	250 mm	250 mm	300 mm
Nominal motor rating	2.2 kW/3Ph	2.2 kW/3Ph	3 kW/3Ph	4 kW/3Ph	5.5 kW/3Ph	7.5 kW/3Ph
Voltage	400 V / 50 Hz	400 V / 50 Hz	400 V / 50 Hz	400 V / 50 Hz	400 V / 50 Hz	400 V / 50 Hz
Nominal flow rate*	1,300 m³ / h	1,300 m³ / h	2,500 m³ / h	3,500 m³ / h	4,500 m³ / h	5,500 m³ / h
Max. flow rate	1,800 m³ / h	2,300 m³ / h	3,300 m³ / h	4,300 m³ / h	5,300 m³ / h	7,300 m³ / h
Max. vacuum	2,100 Pa	2,200 Pa	2,700 Pa	2,500 Pa	2,900 Pa	2,900 Pa
Filter area	2.2 m²	2 x 2.2 m²	3 x 2.2 m²	4 x 3.5 m²	5 x 3.5 m²	6 x 3.5 m²
Swarf collection capacity	175 L	2 x 175 L	3 x 175 L	4 x 175 L	5 x 175 L	6 x 175 L
Dimensions (L / W / H) in mm	1,149 x 578 x 2,115	1,817 x 578 x 2,115	2,486 x 578 x 2,115	3,416 x 787 x 2,754	4,101 x 787 x 2,754	4,786 x 787 x 2,754
Weight netto	61 kg / 74 kg*	76 kg / 103 kg*	98 kg / 139 kg*	182 kg / 238 kg*	207 kg / 277 kg*	236 kg / 319 kg*

\*incl. container

!! Use in the wood industry is not permitted in Germany, Austria and Switzerland !!

# PAINT MIST EXTRACTION COLOUR JET

## FLEXIBLE AND POWERFUL



### The advantages for you:

- | Mobile construction
- | High separation rate, high extraction performance
- | Easy to use
- | Long filter service life and thus little downtime
- | More flexible due to extraction technology with front panel system

## COLOUR JET

Technical data	Type 1	Type 2	Type 3	Type 4
Nominal motor rating	1.5 kW	0.75 / 2.1 kW	0.75 / 2.1 kW	2.2 kW
Motor speed	1,410 min <sup>-1</sup>	960 / 1,430 min <sup>-1</sup>	960 / 1,430 min <sup>-1</sup>	1,430 min <sup>-1</sup>
Airflow rate	4,600 m <sup>3</sup> / h	3,000 / 6,800 m <sup>3</sup> / h	3,000 / 6,800 m <sup>3</sup> / h	6,800 m <sup>3</sup> / h
Usable pressure	500 Pa	400 / 500 Pa	400 / 500 Pa	500 Pa
Dimensions (W / H / D) in mm	1,012 x 1,405 x 912	1,012 x 1,405 x 943	1,912 x 1,405 x 943	1,912 x 1,405 x 943
Dimensions (W / H / D) in mm*	1,897 x 1,405 x 1,135	1,897 x 1,405 x 1,166	2,971 x 1,405 x 1,215	2,971 x 1,405 x 1,215
Filter area	1 m <sup>2</sup>	1 m <sup>2</sup>	2 m <sup>2</sup>	2 m <sup>2</sup>
Weight netto	175 kg	176 kg	248 kg	248 kg

\* with open side sections

# AL-KO BAG

## MOBILE VENTILATION EXTRACTION FAN

### CLEANER AIR AT WORK

- | Fresh air supply for working with construction chemicals
- | Fresh air supply for working with loose materials
- | Fresh air supply for working in rooms with uncomfortable air conditions



## BAG 140 – 200

Technical data	140	200
Intake nozzles	120 mm and 140 mm	120 mm and 200 mm
Rated motor power	1,1 kW / 1 Ph	2,2 kW / 3 Ph
Voltage	230 V / 50 Hz	400 V / 50 Hz
Flow rate	1.650 m <sup>3</sup> / h	2.500 m <sup>3</sup> / h
Vacuum at nominal flow rate	1.750 Pa	2.700 Pa
Filter surface	3 m <sup>2</sup>	3 m <sup>2</sup>
Chippings collection volume	175 L	175 L
Dimensions (L/W/H) in mm	590* x 632 x 835	590* x 632 x 835
Net weight without packaging	approx. 29 kg	approx. 34 kg

\* L with attached filter Δ 2.150 mm

# SAFETY VACUUM CLEANERS JET STREAM

## THE PERFECT ADDITION

## JET STREAM "M"

Technical data	
Nominal dimension	35 mm
Power consumption	1,200 W / 1 Ph
Voltage	230 V / 50 Hz
Max. flow rate	3,180 L / m
max. vacuum	220 mbr
Filter area	0.6 m <sup>2</sup>
Container volume	43 L
Dimensions (L / W / H) in mm	520 x 380 x 695
Weight netto	13.7 kg

Accessories: Trade and industry kit (eight-piece, tube and floor nozzle in the image part of the trade and industry kit)



### The advantages for you:

- | Approved for dust class M
- | Convenient operation thanks to automatic timelag, switch-on and switch-off
- | Antistatic wet and dry cleaner
- | Low-dust disposal using paper filter bags

# SHREDDING, DISCHARGING, BRIQUETTING

## WASTE DISPOSAL – THE CONVENIENT WAY

AL-KO offers the whole range of waste disposal solutions as an added extra to your AL-KO extraction system: rotary lock valves and discharges, shredders and powerful briquette presses that don't just reduce the volume of production waste. Due to high calorific value and the return to heating with non-fossil fuels, briquette presses can contribute to funding your extraction system.

### The advantages for you:

- | Low energy consumption
- | Space-saving construction
- | High-quality workmanship
- | Long service life
- | Low maintenance
- | Easy to operate
- | Excellent value for money



## BRIQUETTE PRESSES

Technical data	APC 30/50	APC 50/70	APV 60	APV 80	APV 100	APV 120
Briquette diameter	50 mm	70 mm	50 mm	60 mm	70 mm	80 mm
Power	30 – 50 kg / h	50 – 70 kg / h	60 – 90 kg / h	80 – 100 kg / h	100 – 150 kg / h	120 – 180 kg / h
Motor rating	5.5 kW	7.5 kW	7.5 kW	7.5 kW	11 kW	11 kW
Weight netto	650 kg	750 kg	820 kg	870 kg	1,000 kg	1,050 kg

## DISCHARGES

The compactly-built discharge is a perfect alternative to a discharge chute. Discharge via flangeable rotary lock valve of 960 or 440 mm. Material buffer facilities.



## ROTARY LOCK VALVES

The AL-KO rotary lock valve discharges loose material, like dust, swarf or granulate, unpressurised from filter systems into silos, containers or big packs. Tested according to ATEX Directive 94/9/EG. Suitable for goods up to a temperature of 50° C.



Technical data	ZRS 440	ZRS 960
Intake	250 x 440 mm	250 x 960 mm
Discharge	208 x 440 mm	208 x 960 mm
Construction height	330 mm	330 mm
Total weight	70 kg	100 kg
Max. conveyor capacity at 4 rpm by rotary valve	7,250 L / h	15,816 L / h
Max. conveyor capacity at 12 rpm by rotary valve	21,750 L / h	47,450 L / h
Temperature range	up to 130° C	up to 130° C



# PLANNING AND INSTALLATION

## STATIONARY EXTRACTION SYSTEMS FROM ONE SOURCE

As a manufacturer of stationary and mobile extraction systems, AL-KO maintains an international network of independent contractual partners in the plant engineering sector who provide a range of services under one roof, from planning to installation and initial start-up of your AL-KO system. Project management services for dust extraction systems for one or several factory buildings or workshops are also provided by AL-KO's contractual partners. They are your local point of contact for all service, maintenance and warranty inquiries.

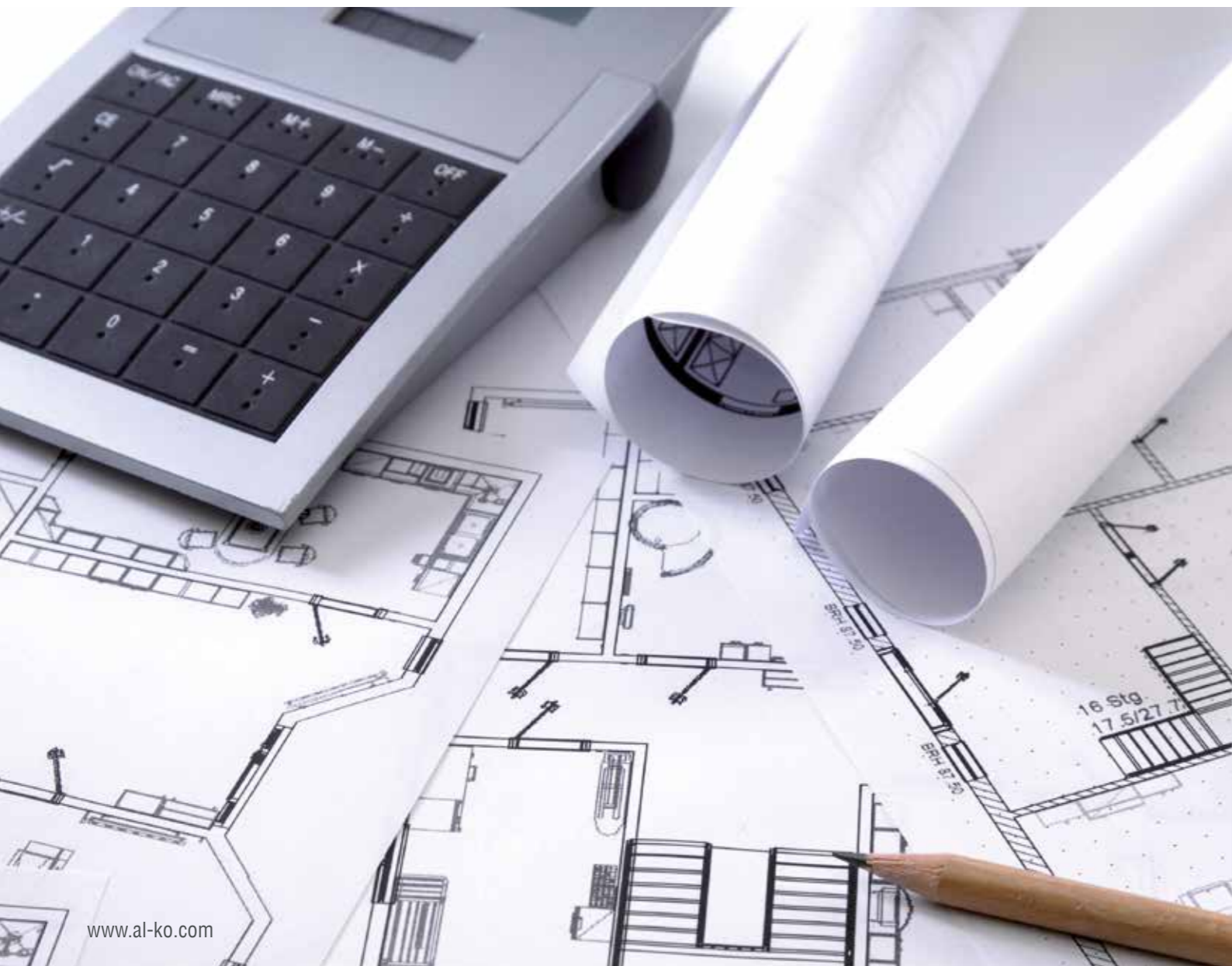

# REDUCING LIFE CYCLE COSTS

## EXTRACTION SYSTEMS WITH LOWER INVESTMENTS COSTS USUALLY LEAD TO FAR HIGHER OPERATING COSTS THAN NECESSARY!

"Cheap can get really expensive." This simple saying can quickly become bitter truth when follow-up costs are not taken into consideration when making investments of any kind.

This is all the more so when they add up to the same or even higher amount than the original investment costs.

It is also particularly true for extraction devices and systems for production processes where annual operating costs, i.e. costs for energy, maintenance and service, can amount to as much as the one-off investment costs. However, experience shows that high-quality technology and optimised system configurations contribute to the significant reduction of annual energy costs – without reducing the extraction functions.

The profitability of a dust extraction system is hence not only determined by a low initial investment or low operating costs. Apart from the devices' and systems' unlimited and appropriate functionality, life cycle costs (LCC) or total costs of ownership (TCO), as the sum of all associated costs from manufacturing to disposal, are the only criteria for evaluating extraction systems.

Discover the economic and ecological potential of dedusting and find out how to make the most of it.

Yours sincerely,

Prof. Dr.-Ing. Michael Haibel



**Prof. Dr.-Ing. Michael Haibel / University of Applied Sciences Biberach**

World-renowned expert for buildings, building technology and energy systems as well as R&D advisor at AL-KO Luft- und Klimatechnik.

## **AL-KO EXTRACTION TECHNOLOGY – YOUR STRONG PARTNER**

In Europe and across the world, thousands of customers every year choose quality products from AL-KO Extraction Technology. The enthusiasm for these products and customers' confidence in us demonstrates that even today, products bearing the "MADE IN GERMANY" label have a future – if they are consistently based on innovation and superior quality.

Look to the future with us, and as our customer and partner profit from the performance, the quality and the security offered by the AL-KO brand.

**AL-KO THERM GMBH**  
**Extraction technology division**  
Hauptstraße 248 – 250  
89343 Jettingen-Scheppach  
Germany  
Tel. +49 8225 39-2412  
Fax +49 8225 39-2435  
absaug.technik@al-ko.de  
**www.al-ko.com**

Figures show configuration examples which are not available in every market.  
Please ask your AL-KO advisor.

Provided by your AL-KO partner:

Subject to modifications in response to technical developments.  
No liability accepted for mistakes and printing errors. As of 02-2016